

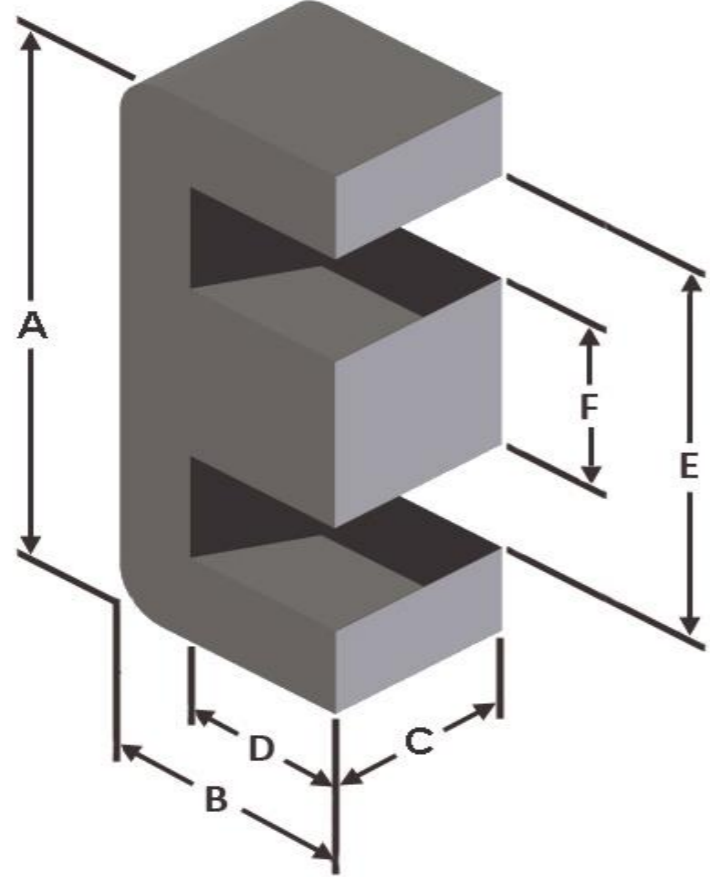

Part Number: EMS-0190805-090

Revision 20160816 - Generated 2016-Aug-16



A	19.3 ± 0.30 mm	0.760 ± 0.012 in
B	8.1 ± 0.18 mm	0.319 ± 0.007 in
C	4.78 ± 0.15 mm	0.188 ± 0.006 in
D	5.54 mm (min.)	0.218 in (min.)
E	13.9 mm (min.)	0.547 in (min.)
F	4.78 ± 0.13 mm	0.188 ± 0.005 in
Mass	(approximate)	2.7 grams/half
Magnetic Dimensions	A _e - Eff. Mag. Cross Section	0.228 cm ²
	L _e - Eff. Mag. Path Length	4.01 cm
	V _e - Eff. Core Volume	0.914 cm ³
	WA - Min. Eff. Window Area	0.498 cm ²
	sa - Surface Area	11.9 cm ²
	mlt - mean length per turn	3.74 cm
Inductance	μ _i (reference)	90
	A _L value (nominal)	69 nH/N ²
	Test Winding	N=100, #26 AWG
	Frequency	10 kHz
	Voltage on Agilent 4284A	0.10 V
	A _L tolerance	±8%
Core Loss	$\text{Core Loss (mW/cm}^3\text{)} = \frac{f}{\frac{a}{B_{pk}^3} + \frac{b}{B_{pk}^{2.3}} + \frac{c}{B_{pk}^{1.65}}} + d \cdot B_{pk}^2 \cdot f^2$	
	where B _{pk} expressed in gauss, f expressed in hertz, and: a=1.46E+09, b=8.28E+08, c=4.62E+06, d=1.09E-14	
	B _{pk}	1000 G
	frequency	50 kHz
	Core Loss (nominal)	345 mW/cm ³
Core Loss (maximum)	396 mW/cm ³	
DC Saturation	$\% \mu_i = \frac{1}{a + b \cdot H^c} + d$	
	where H expressed in oersteds, and: a=0.01, b=1.26E-05, c=1.70, d=0.00	
	H _{DC}	50 Oe
	Percent Initial Perm(nom.)	50.6%
Percent Initial Perm(min.)	42.9%	
Coating/Pkg	Coating Type:	None
	Voltage Breakdown (min.)	N/A
	Limit	N/A
	Package Quantity	1,080 Halves/Box

Winding Table	Wire Size	AWG	16	18	20	22	24	26	28	30	32	34	36
		mm	1.250	1.000	0.800	0.630	0.500	0.400	0.315	0.250	0.200	0.160	0.125
	Full Winding	Turns	15	24	37	57	88	137	212	328	508	786	1,216
	Rdc(Ω)		7.4 m	18.8 m	46.0 m	112.7 m	276.7 m	685.0 m	1.7	4.1	10.2	25.1	61.9

