

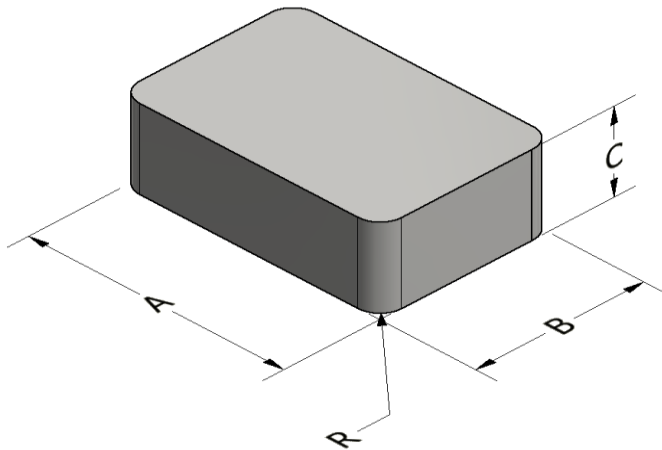

**Part Number:** **BMS-0803035-125**

Revision 20160414 - Generated 2016-Apr-28



<b>A</b>	80.00 ± 0.50 mm	3.150 ± 0.020 in
<b>B</b>	30.00 ± 0.50 mm	1.181 ± 0.020 in
<b>C</b>	35.00 ± 0.50 mm	1.378 ± 0.020 in
<b>R</b>	1.5 ± 0.50 mm	0.059 ± 0.020 in
	$\mu_i$ (reference)	125
<b>Mass</b>	(approximate)	490 grams
<b>Core Loss</b>	$\text{Core Loss (mW/cm}^3\text{)} = \frac{a}{B_{pk}^3} + \frac{b}{B_{pk}^{2.3}} + \frac{c}{B_{pk}^{1.65}} + d \cdot B_{pk}^2 \cdot f^2$	
	where $B_{pk}$ expressed in gauss, $f$ expressed in hertz, and: $a=1.03E+09$ , $b=2.22E+09$ , $c=1.00E+03$ , $d=1.96E-14$	
	$B_{pk}$	1000 G
	frequency	50 kHz
	Core Loss (nominal)	227 mW/cm <sup>3</sup>
Core Loss (maximum)	261 mW/cm <sup>3</sup>	
<b>DC Saturation</b>	$\% \mu_i = \frac{1}{a + b \cdot H^c} + d$	
	where H expressed in oersteds, and: $a=0.01$ , $b=3.15E-05$ , $c=1.62$ , $d=0.00$	
	$H_{DC}$	40 Oe
<b>Coating/Pkg</b>	Coating Type:	None
	Voltage Breakdown (min.)	N/A
	Limit	N/A
	Package Quantity	30 Pieces/Box

